

ORIGINAL KETTLE

47cm

57cm



ASSEMBLY GUIDE

PANDUAN MERAKIT

組み立てガイド

조립 설명서

คู่มือการประกอบชิ้นส่วน

组装指南

Read the owner's guide before using the barbecue.

Baca panduan pemilik sebelum menggunakan pemanggang ini.

バーベキューのご使用前に製品の取扱説明書をお読みください

그릴을 사용하기 전에 사용자 설명서를 읽어보십시오.

อ่านคู่มือผู้ใช้ก่อนใช้เตาอย่างบาร์บีคิว

使用烤架之前请阅读用户指南。



51853

090619

ASIA

1

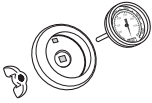

1



1

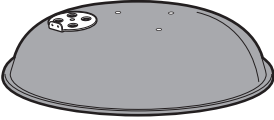

1

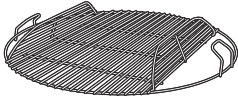

1



1

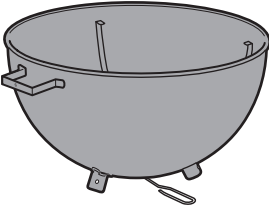

1



1

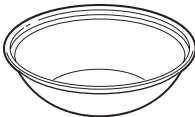

2



1

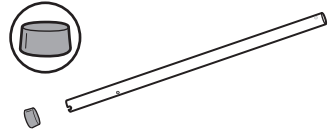

1

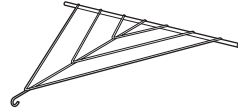

2

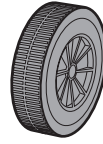

1



EN TOOLS INCLUDED:

ID PERALATAN YANG DISERTAKAN:

JA 同梱ツール:

KO 제공되는 도구:

TH เครื่องมือรวมถึง:

ZH 所含工具:



EN TOOLS REQUIRED:

ID PERALATAN YANG DIBUTUHKAN:

JA 必要なツール:

KO 필요한 도구:

TH เครื่องมือที่ต้องใช้:

ZH 所需工具:

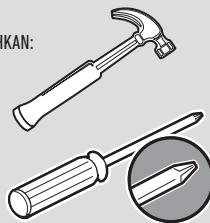

2



2

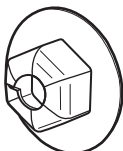

3

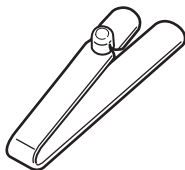

3



1

3-

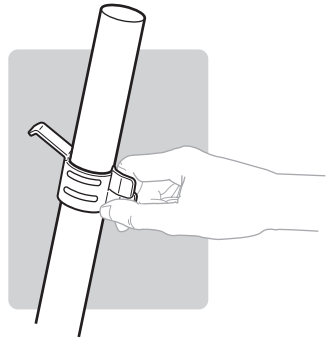
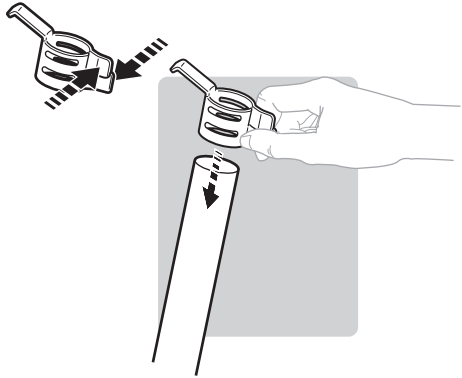
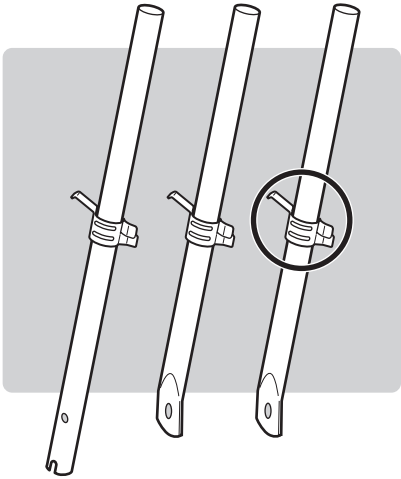

2

1-

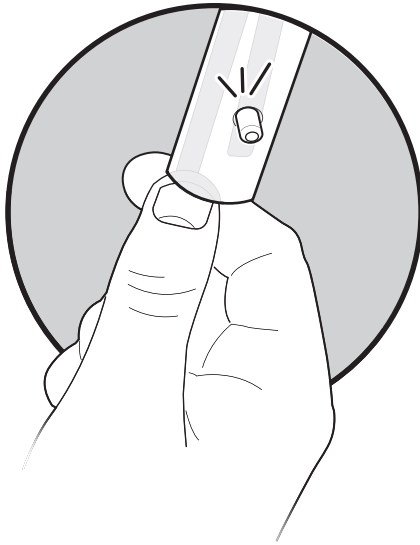
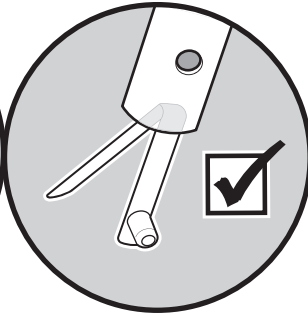
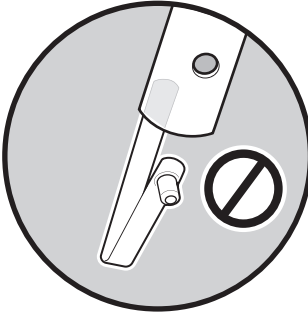
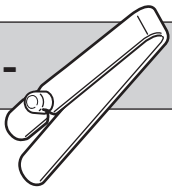

3

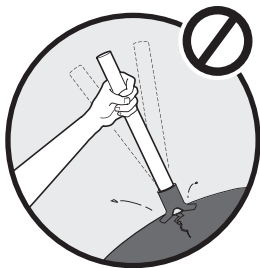
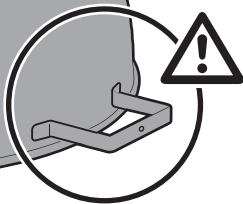
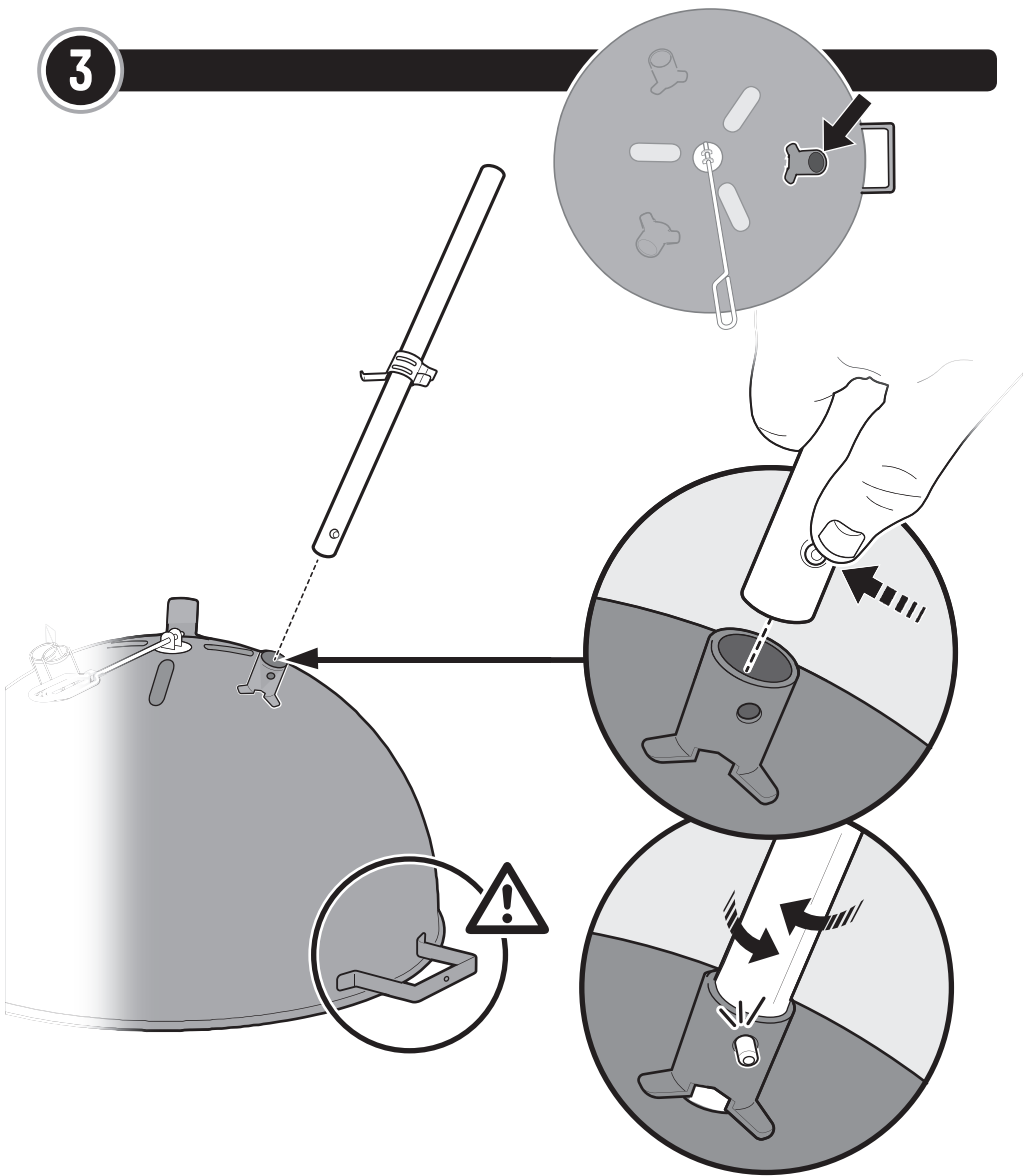

4

1-

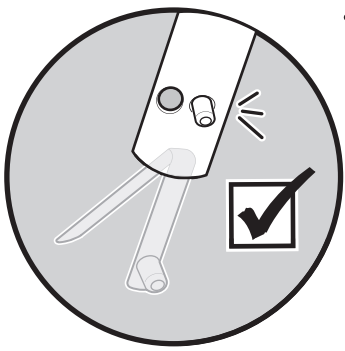
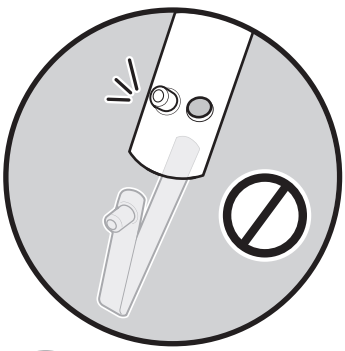
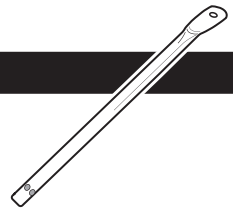
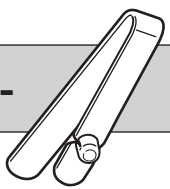

5

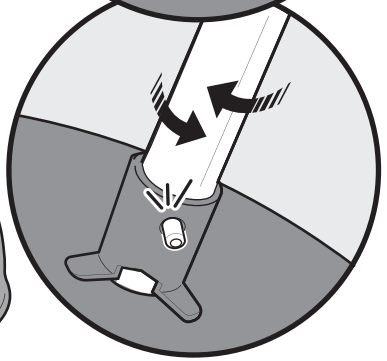
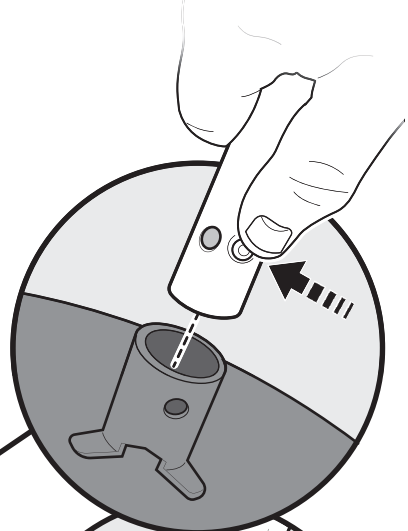
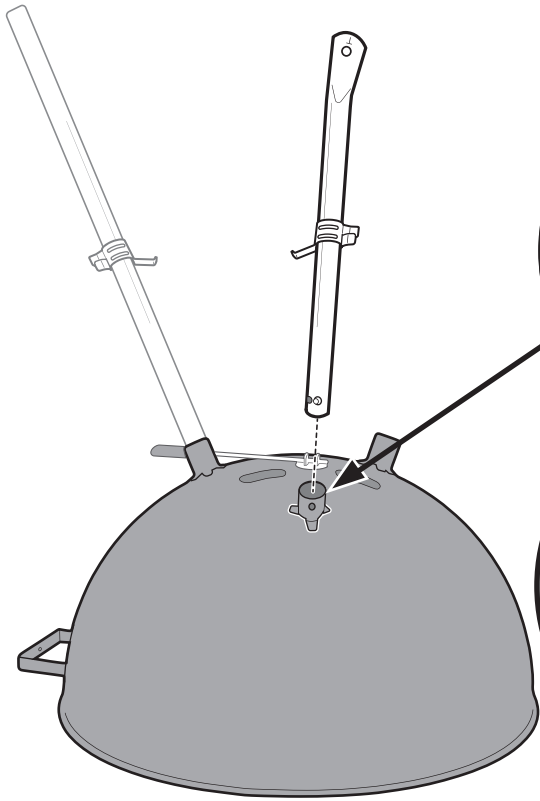

6

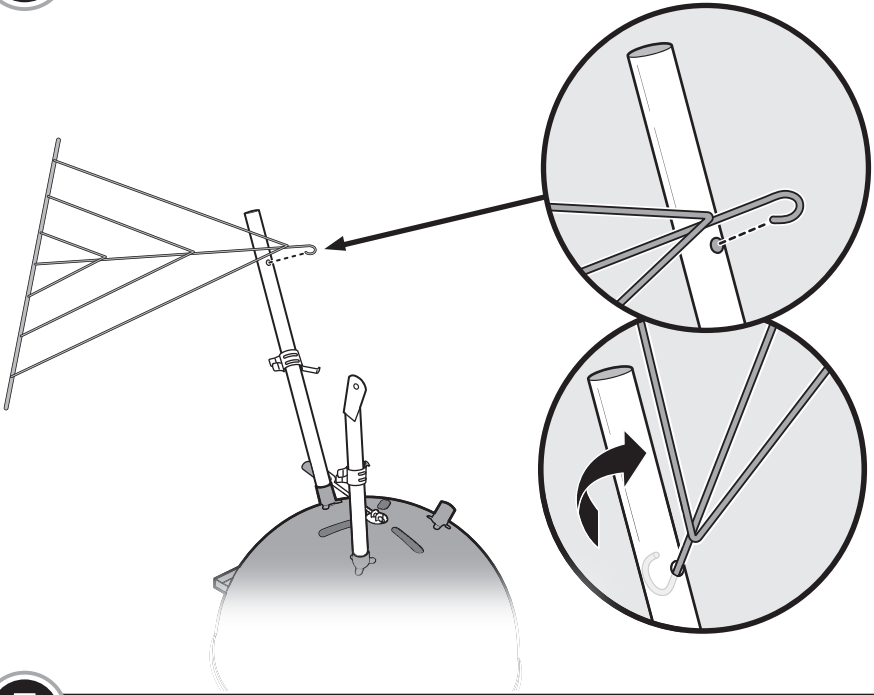

7

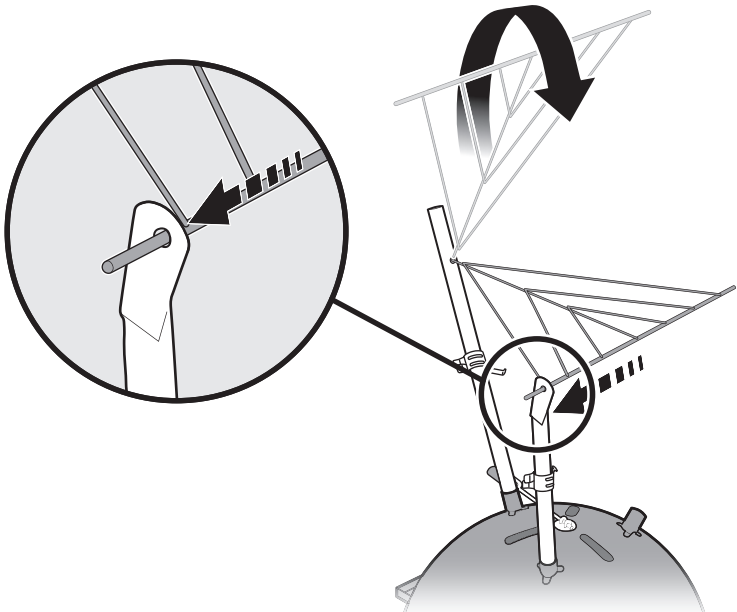

8

1-

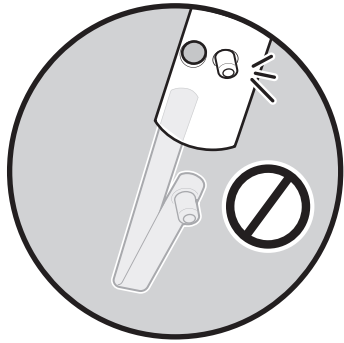
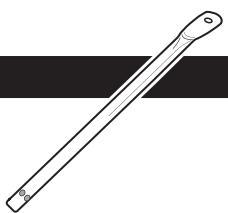
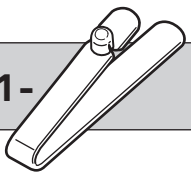

9

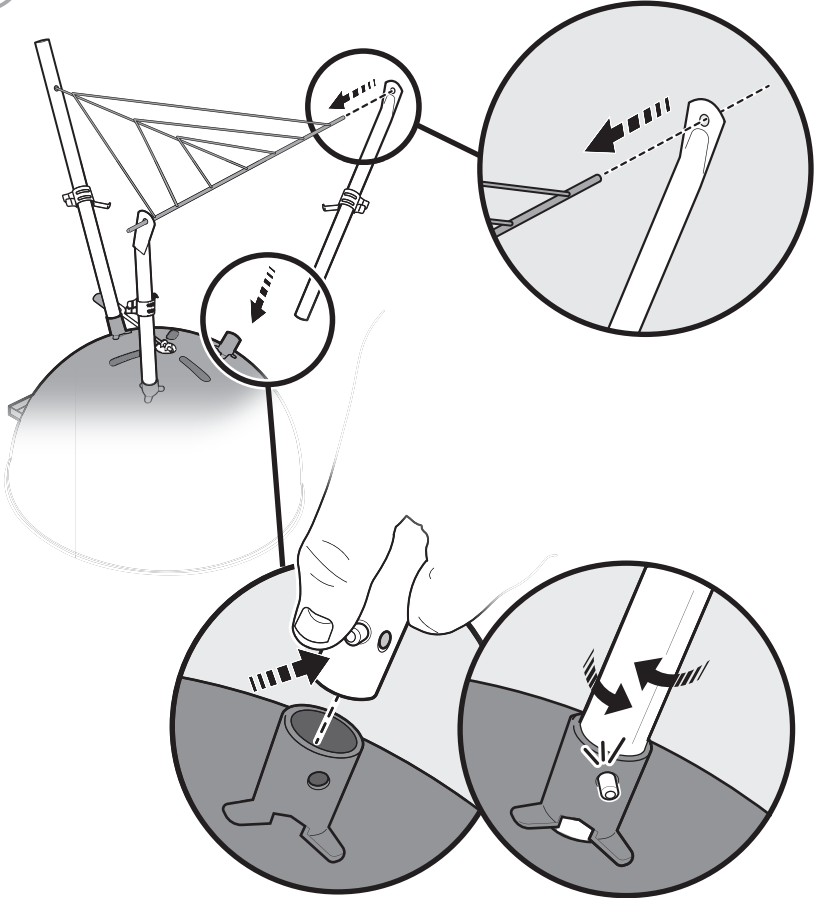

10

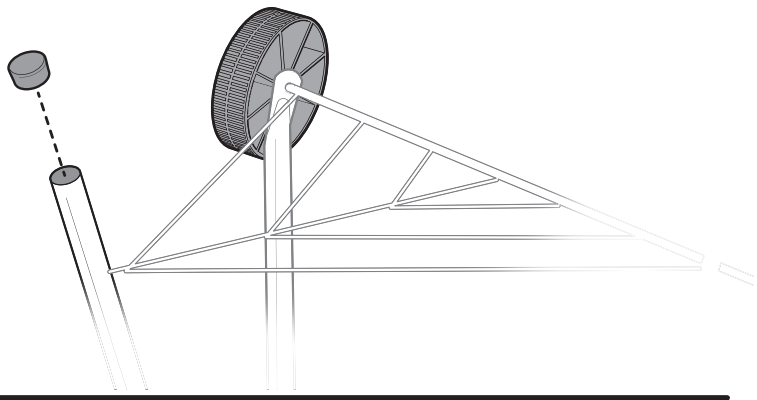
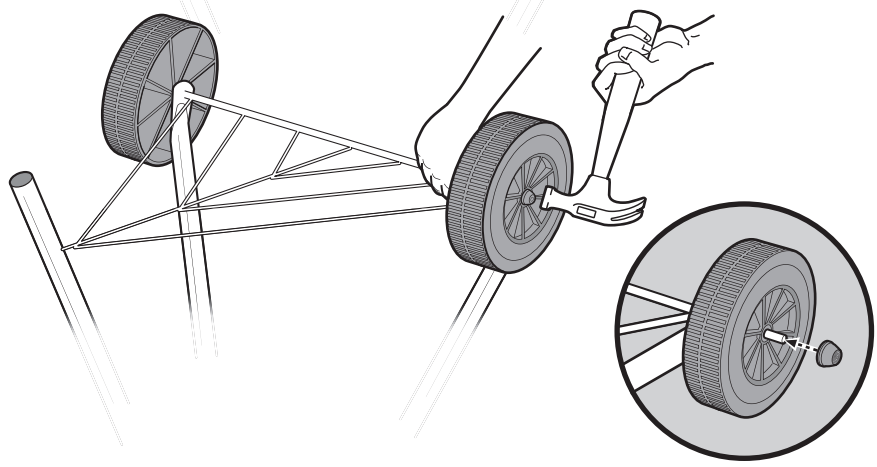
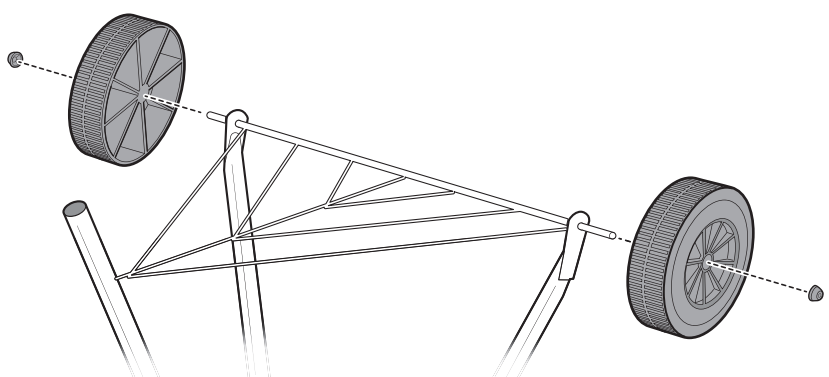

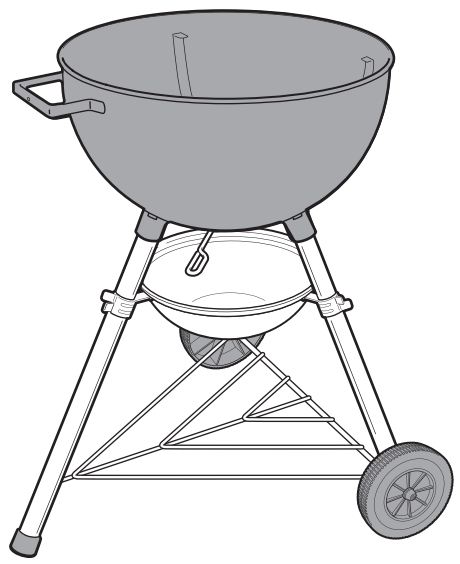
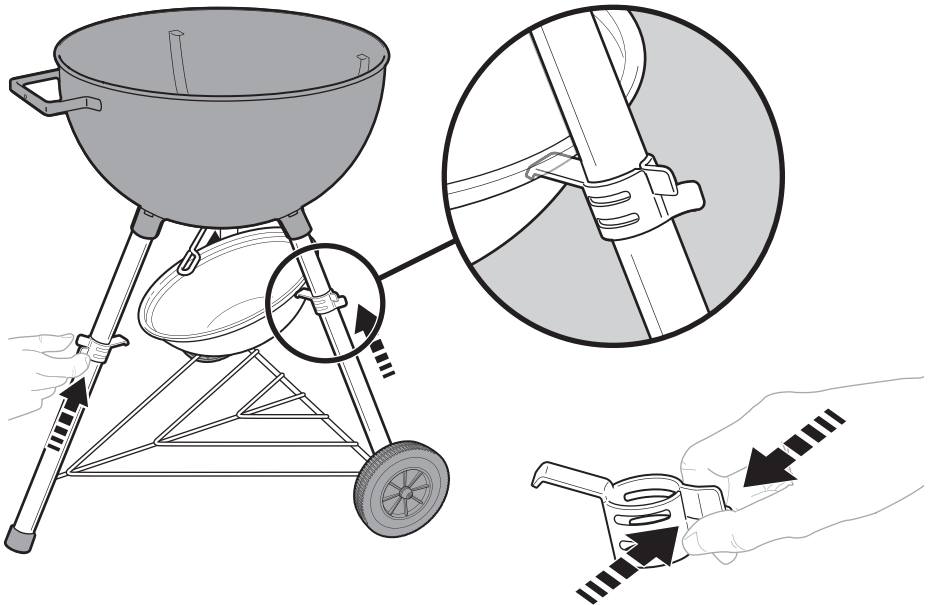

13

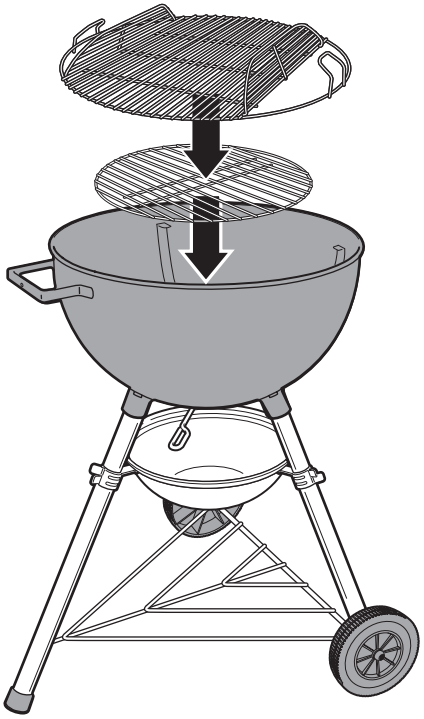

14

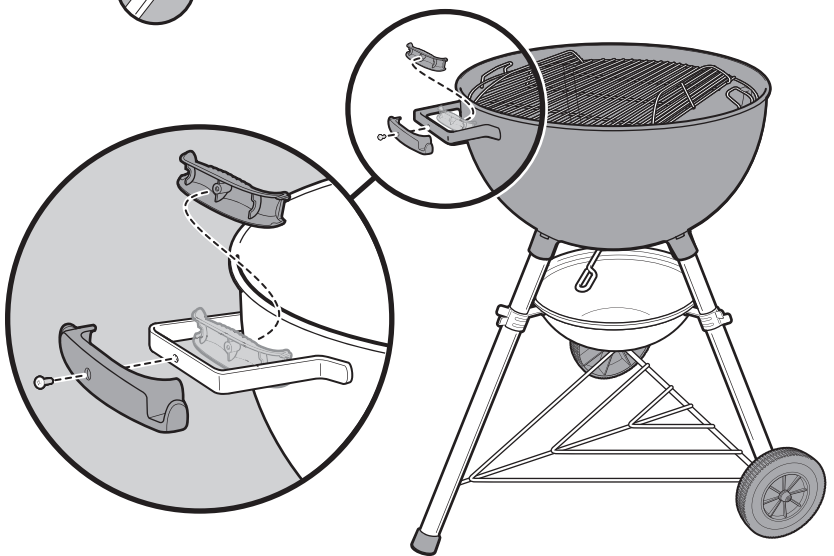
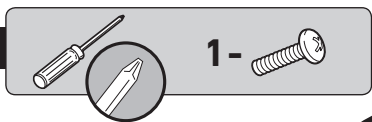

15



2-

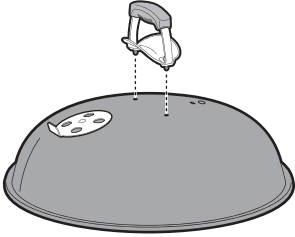
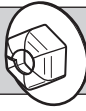

⚠ DO NOT OVER TIGHTEN.

⚠ JANGAN KENCANGKAN TERLALU KETAT.

⚠ きつく締め過ぎないでください

⚠ 과도하게 조이지 말 것

⚠ อย่าขันแน่นจนเกินไป

⚠ 请勿过紧。

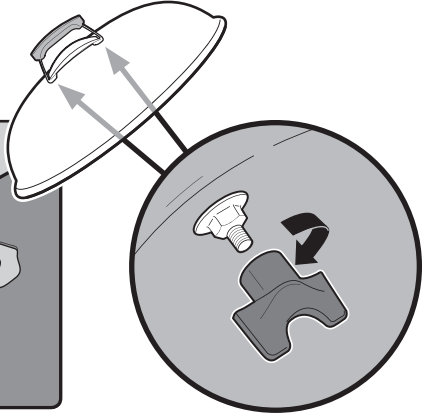
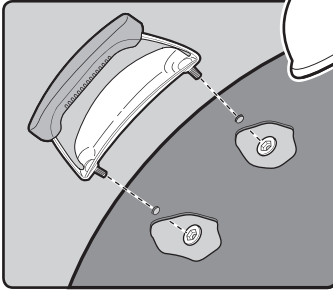

16



1-

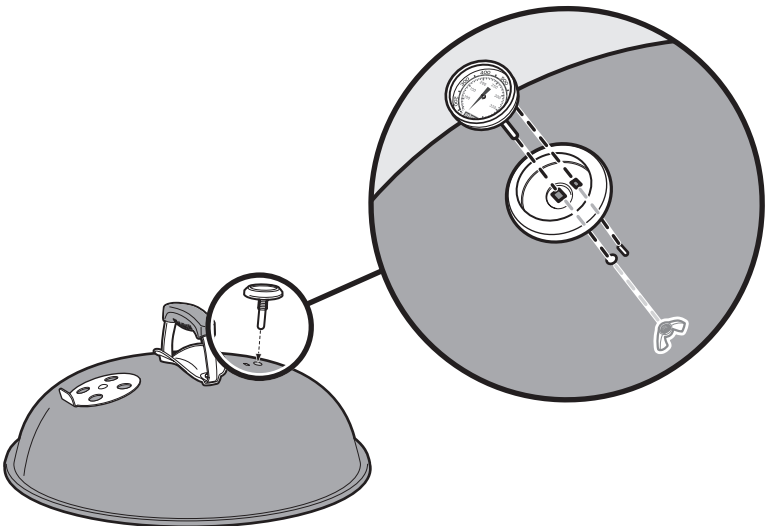

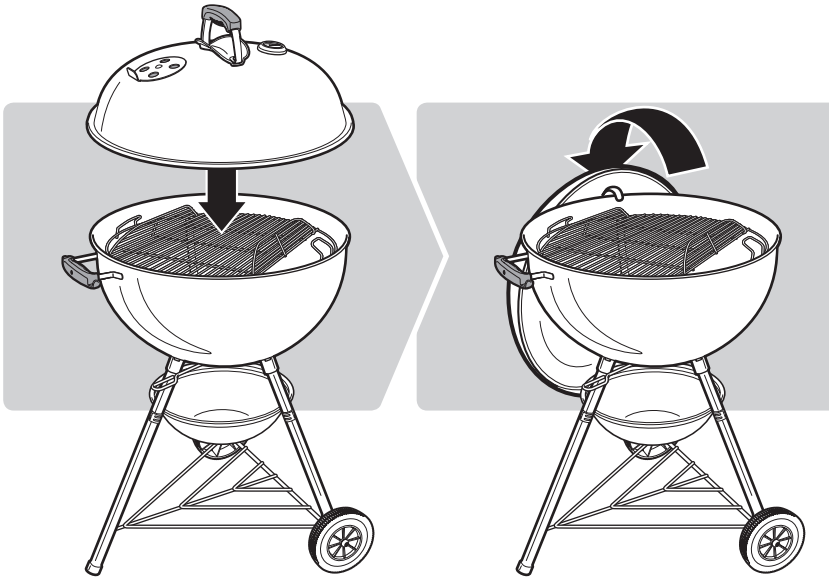

- EN** Make sure that all parts are assembled and hardware is fully tightened before operating the barbecue.
- ID** Sebelum mengoperasikan pemanggang, pastikan semua komponen sudah dirakit dan tidak ada komponen yang longgar.
- JA** バーベキューの使用前に、すべての部品の組み立てが済んでおり、金具がしっかり締まっているか確認してください。
- KO** 바베큐를 사용하기 전, 모든 부품이 조립되어 있고 하드웨어가 견고하게 체결되어 있는지 확인하십시오.
- TH** ตรวจสอบให้แน่ใจว่ามีการประกอบครบทุกชิ้นส่วนและขันอุปกรณ์ให้แน่นก่อนที่จะใช้เตาย่างบาร์บีคิว
- ZH** 操作烤架前, 请确保装配所有零件并牢固拧紧金属构件。

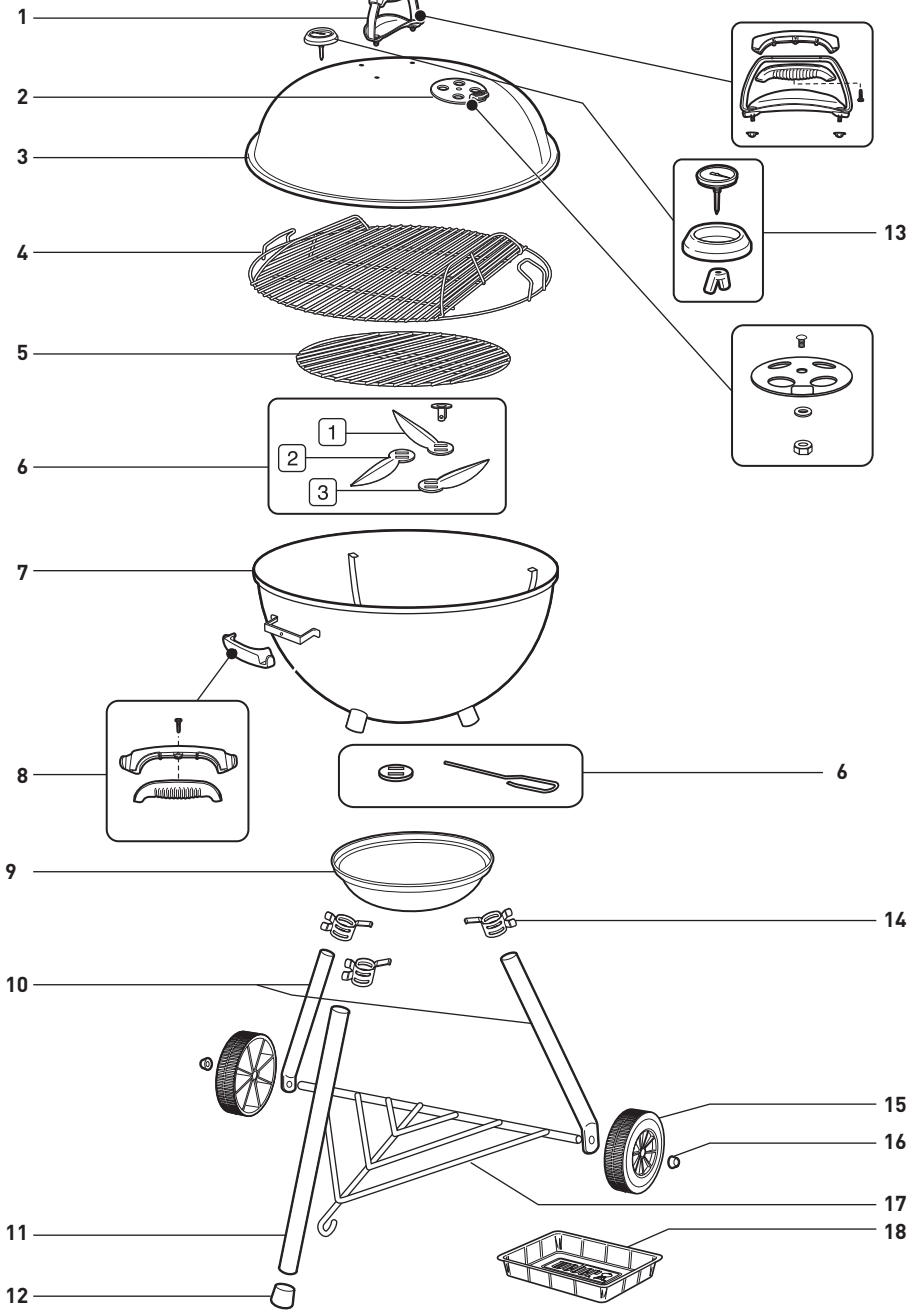



WEBER-STEPHEN PRODUCTS LLC
www.weber.com

© 2019 Designed and engineered by Weber-Stephen Products LLC,
1415 S. Roselle Road, Palatine, Illinois 60067 USA.